

P1

140050

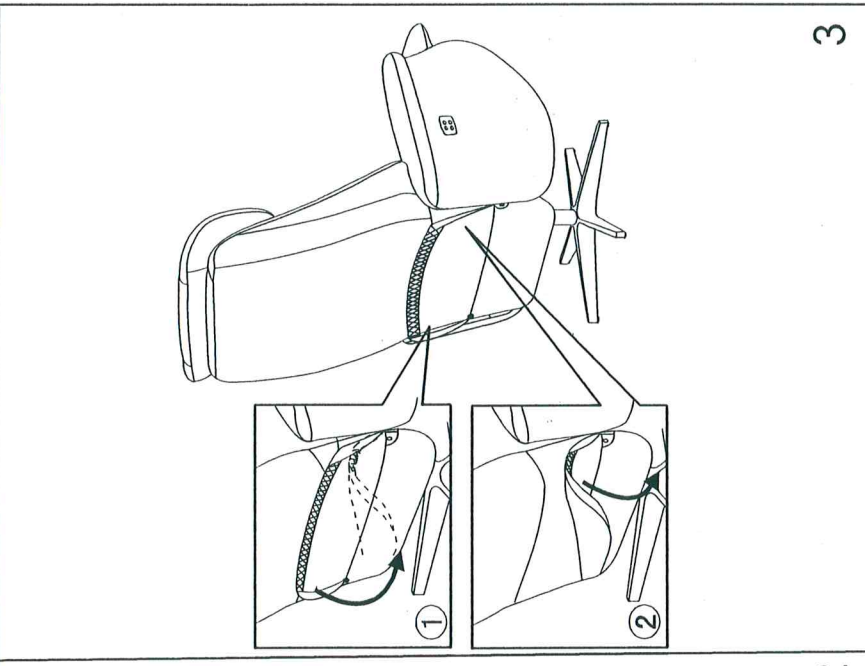

User Guide

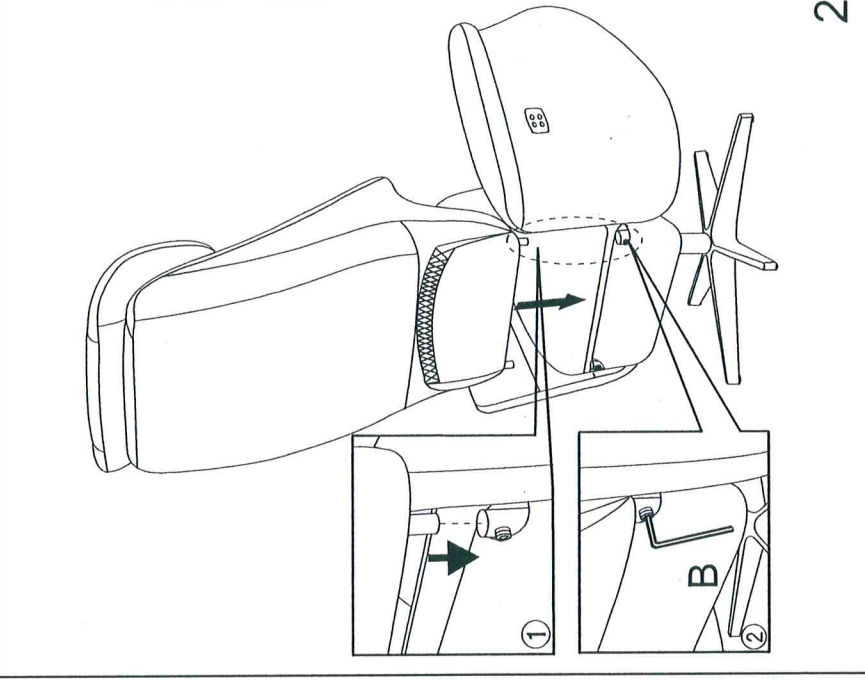
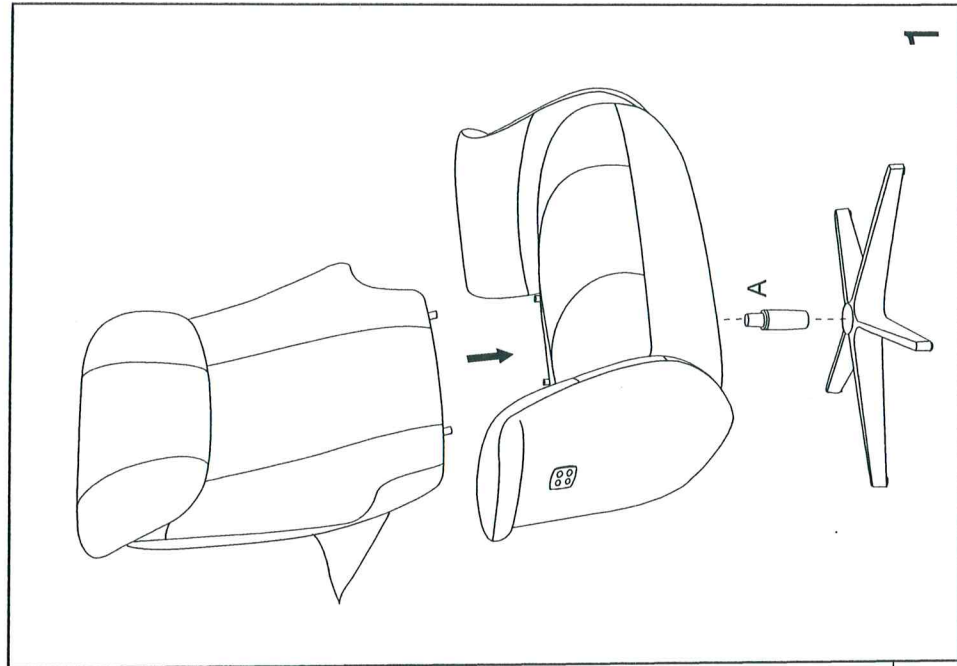
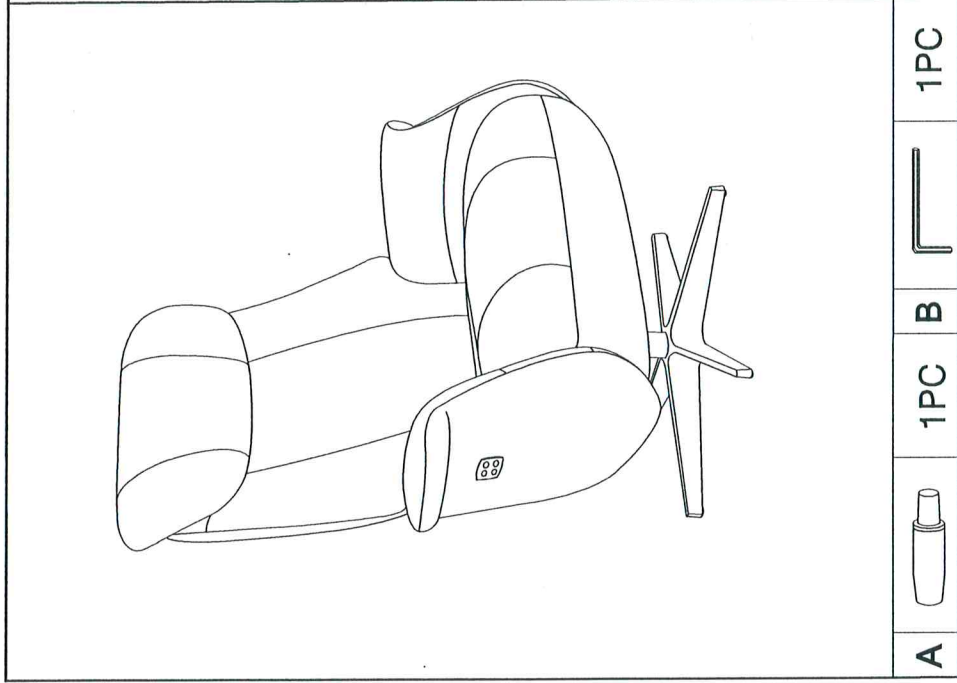
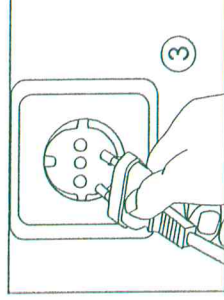
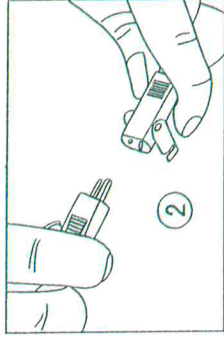
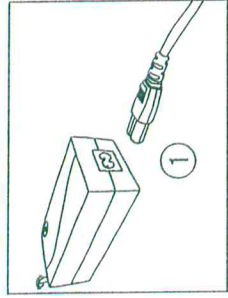

1

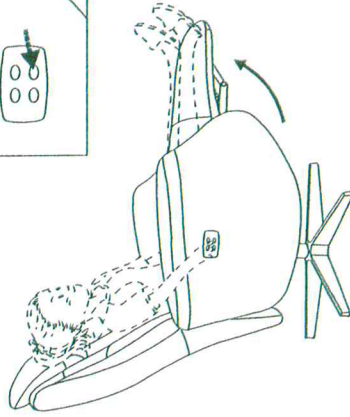

1. Press the button to raise the ottoman

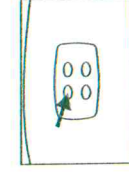

2

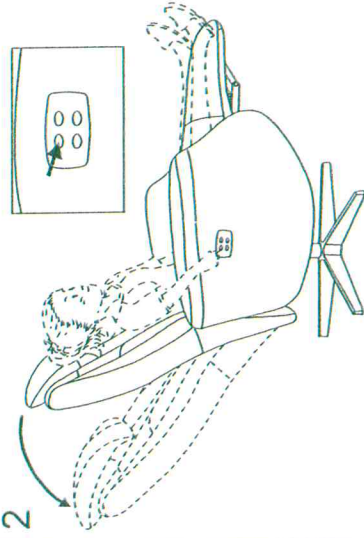

2. Press the button to recline

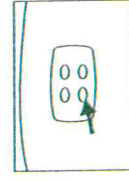

3

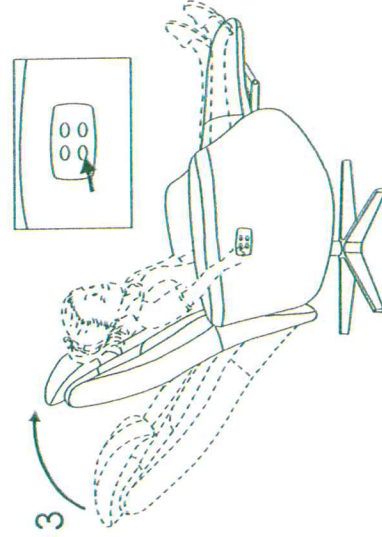

3. Press the button to return to upright position



4

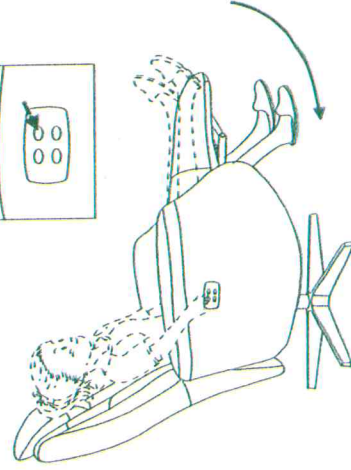

4. Press the button to stow the ottoman

HOW TO ADJUST HEADREST

P3



To adjust headrest: pull from back on both sides as shown.

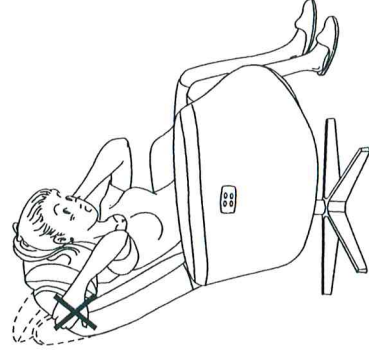

Do not pull from side edge to adjust, material may tear.

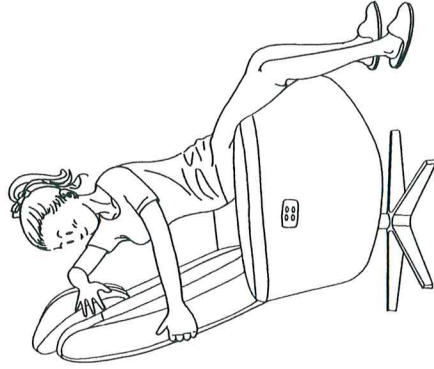

To return headrest back: push on both sides or use forearm to evenly move headrest back.

CAUTION-
Do not push in the center of the headrest as this may cause foam cushion to collapse.

