

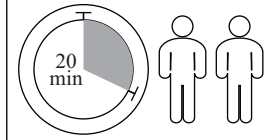

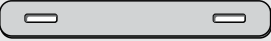

# CA614 - Triple Bay Hutch Unit Assembly Instructions

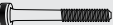

	X 2
	X 6
	X 2
	X 2
	X 2
	X 1
	X24
	X 6

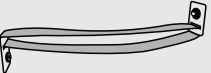

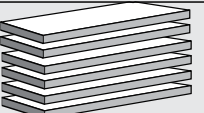
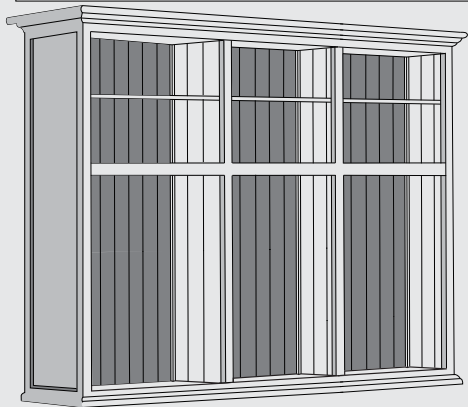
X 1

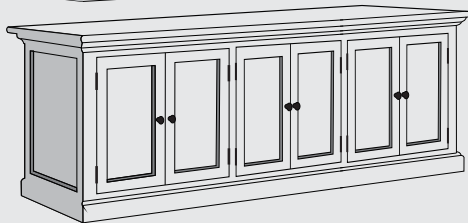

X 1

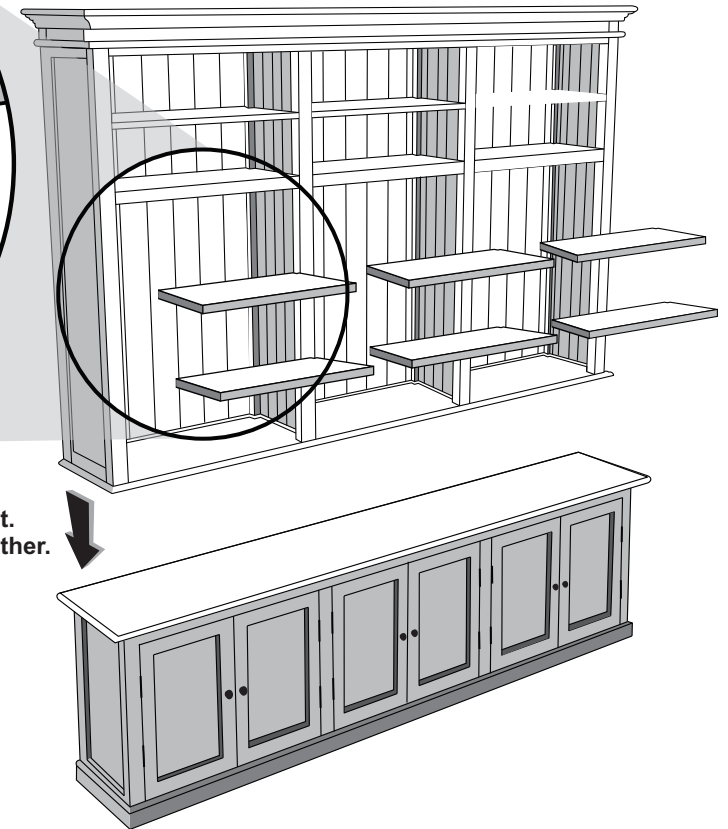
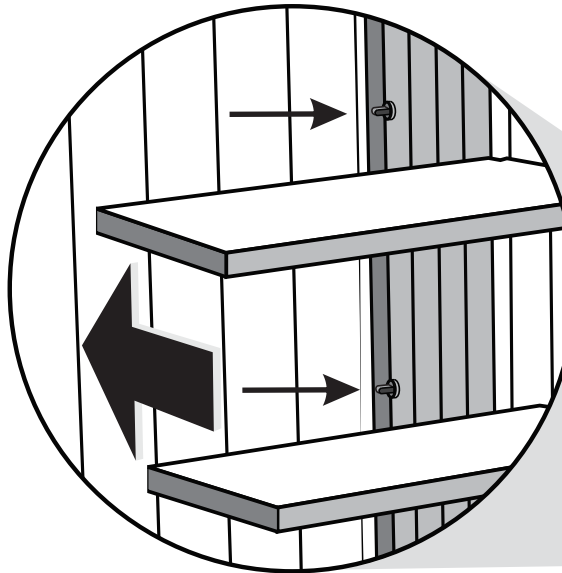

\* Each shelf is identified with a unique code.  
Each code corresponds to a component compartment.  
Corresponding components must be assembled together.

**WARNING** Do not use this product before installing hardware as instructed  
During assembly tighten screws by hand. Once all screws are in place use the tool to tighten until secure

# CA614 - Triple Bay Hutch Unit Assembly Instructions

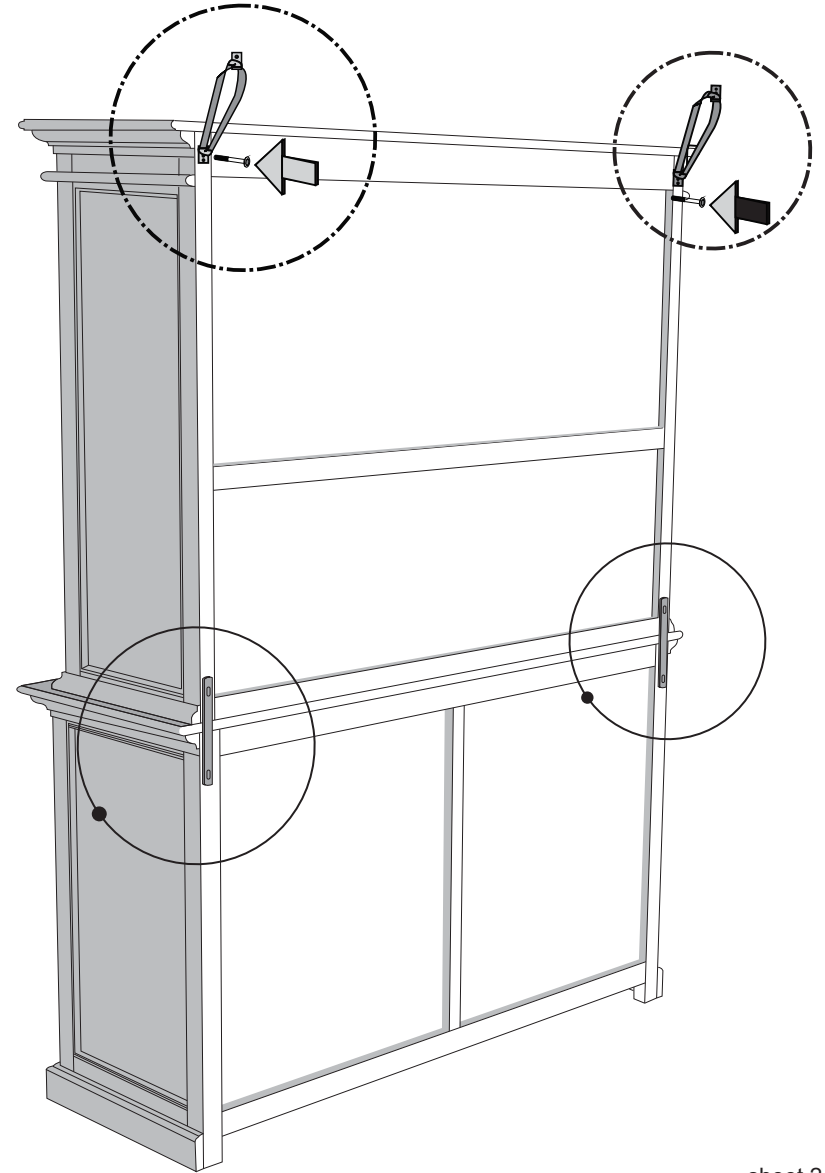
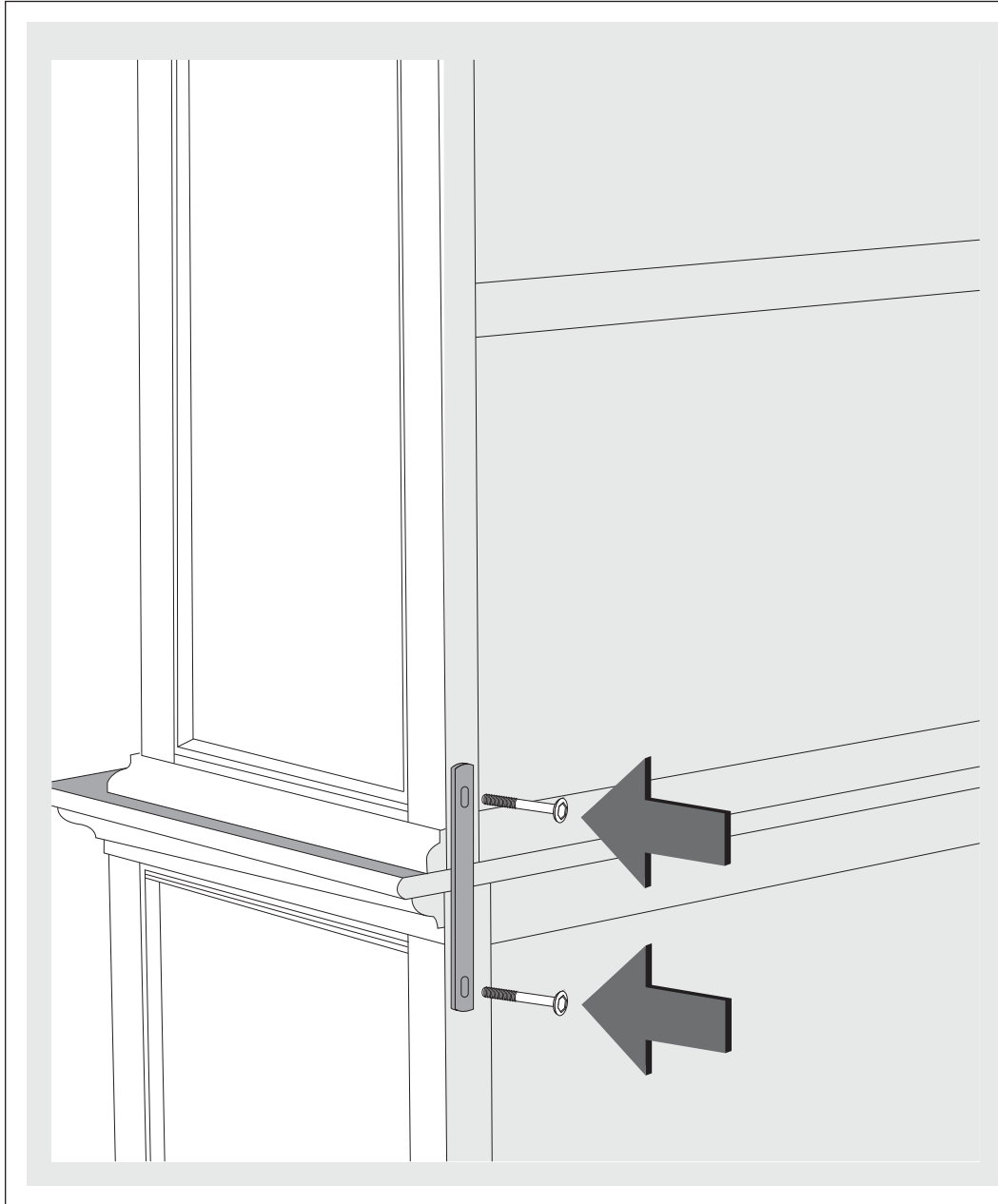

sheet 2

**WARNING** Do not use this product before installing hardware as instructed  
During assembly tighten screws by hand. Once all screws are in place use the tool to tighten until secure

[novasolo.com](http://novasolo.com)