

Technical Drawing

W001

Halifax Wardrobe

190cm x 110cm x 55cm

NOVA 3070





PERSPECTIVE

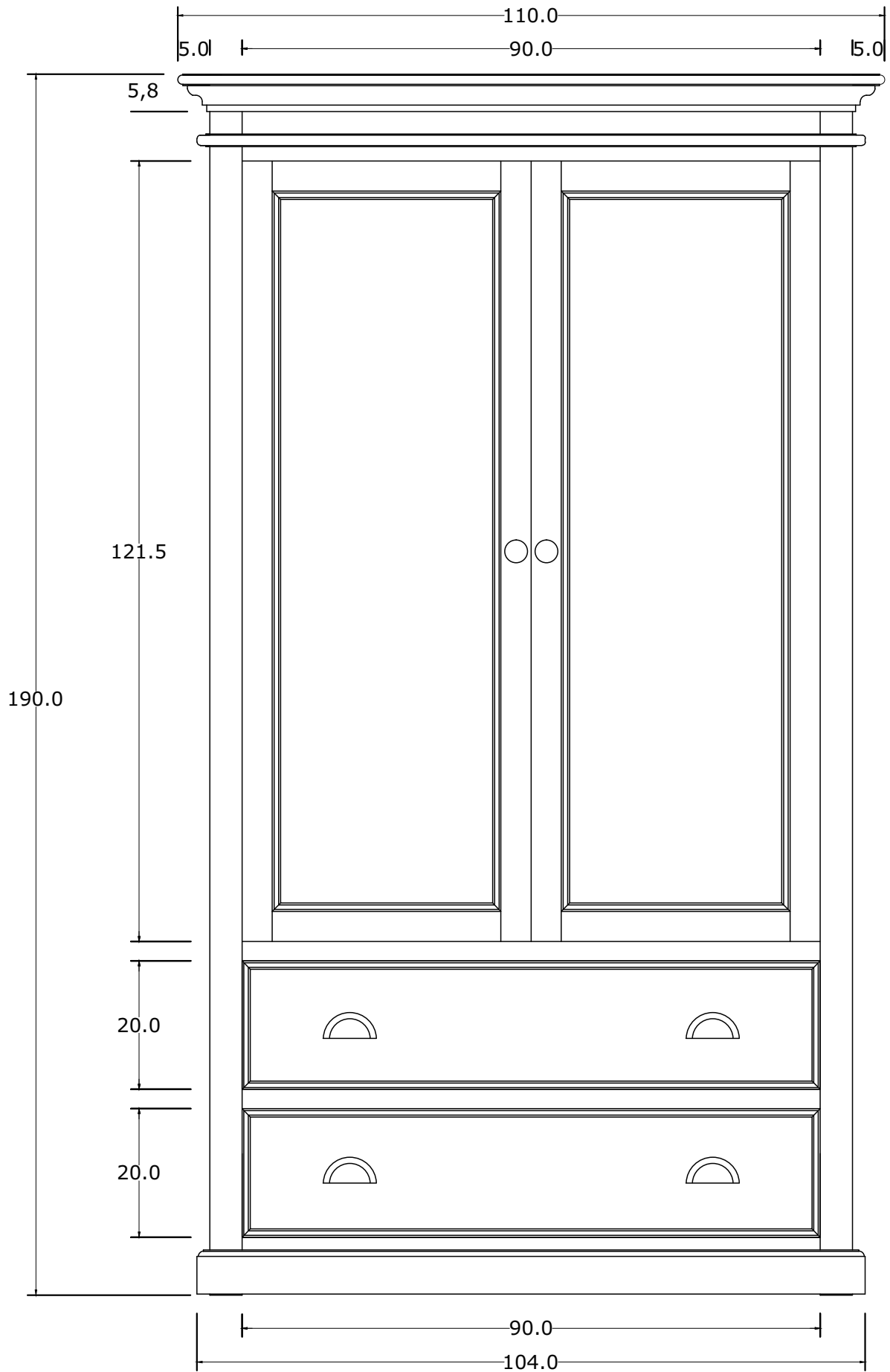

FRONT VIEW

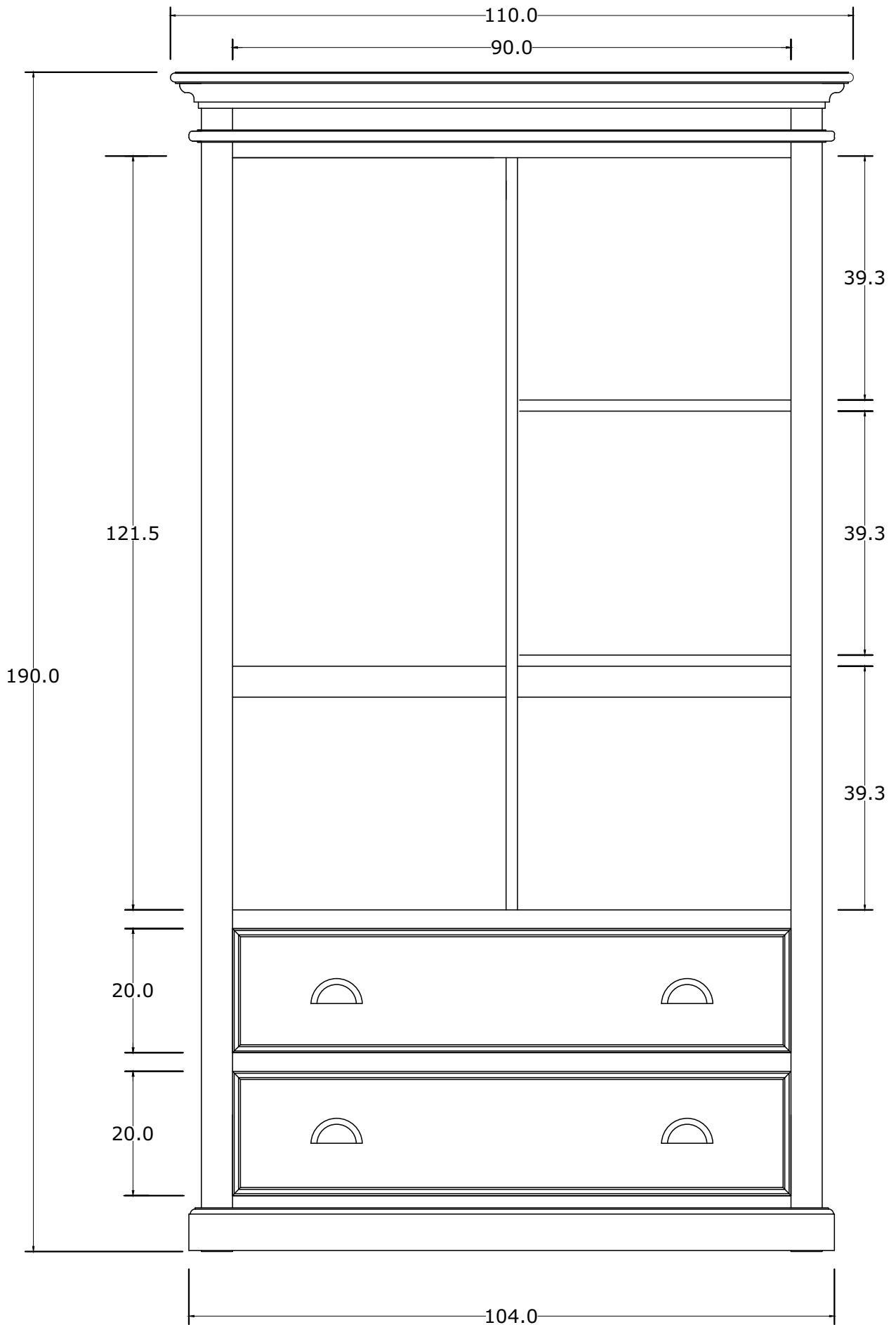

FRONT OPEN VIEW

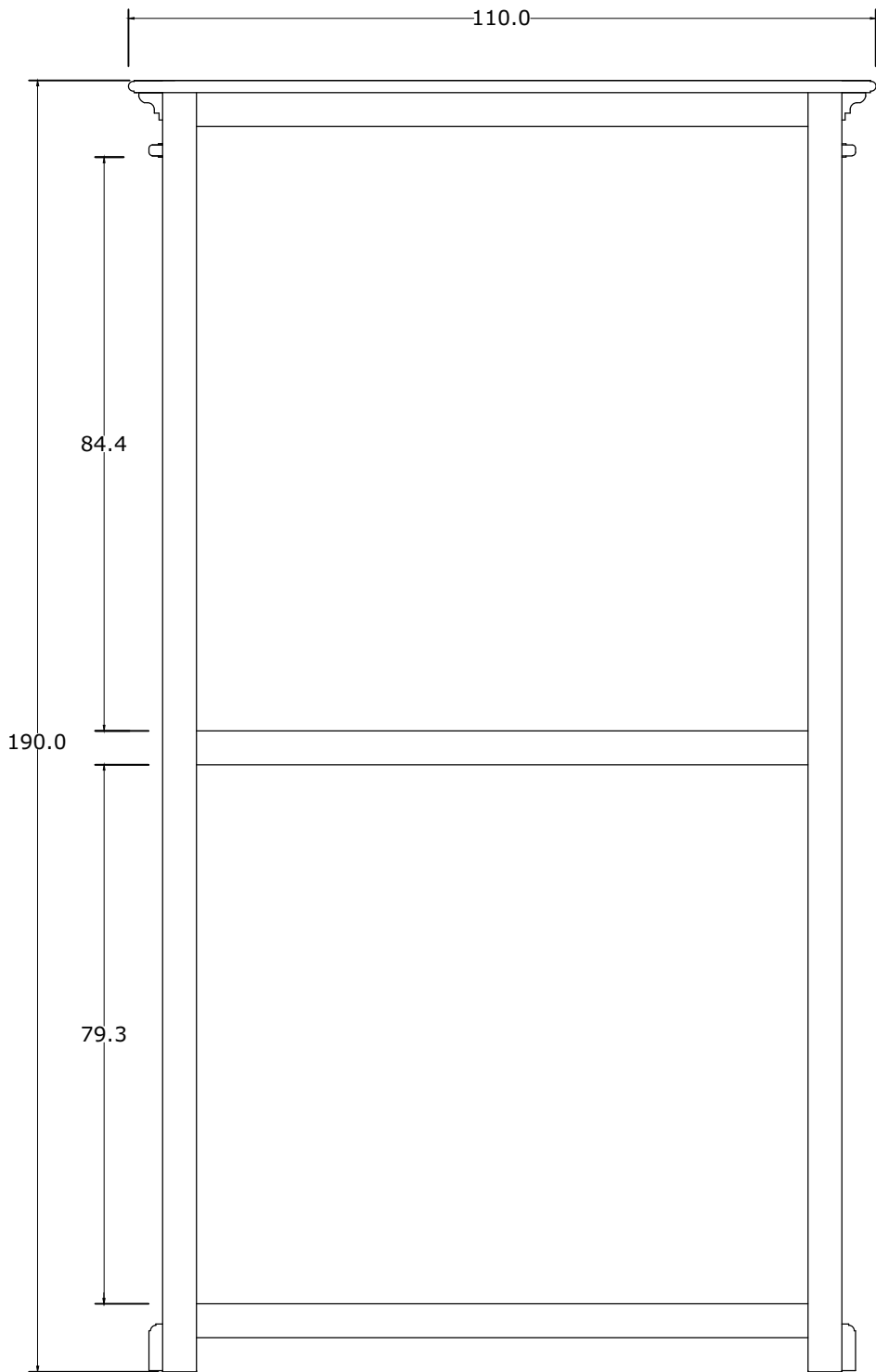

BACK VIEW

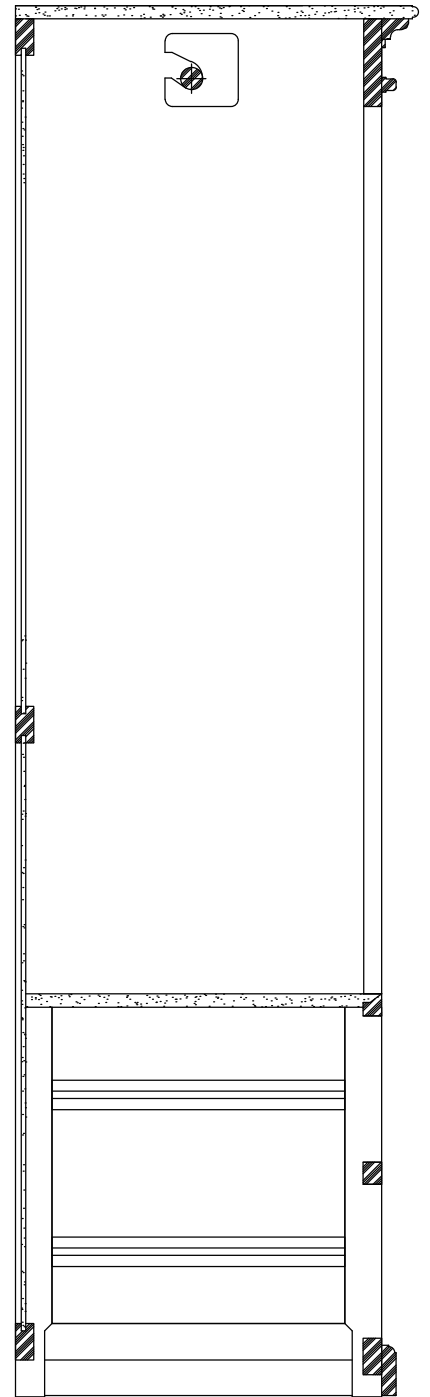

SECTION VIEW

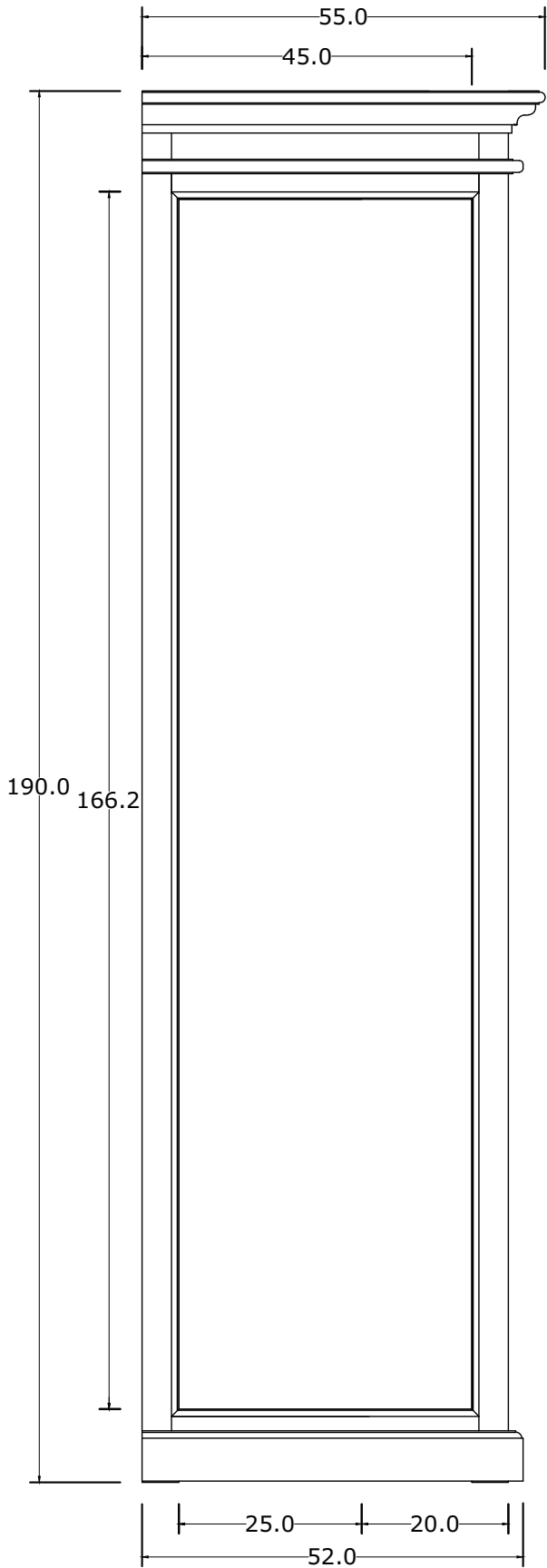

SIDE VIEW

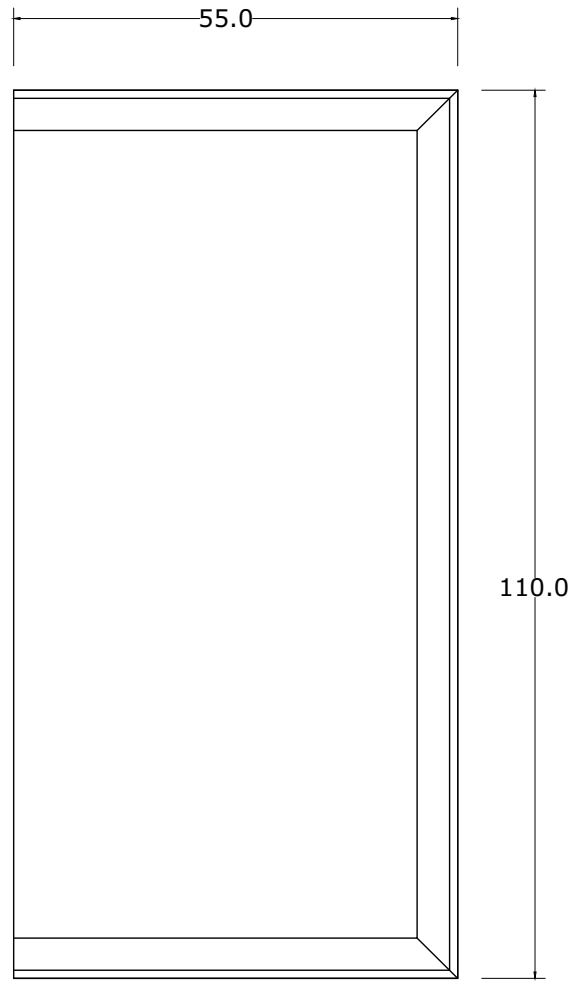

TOP VIEW

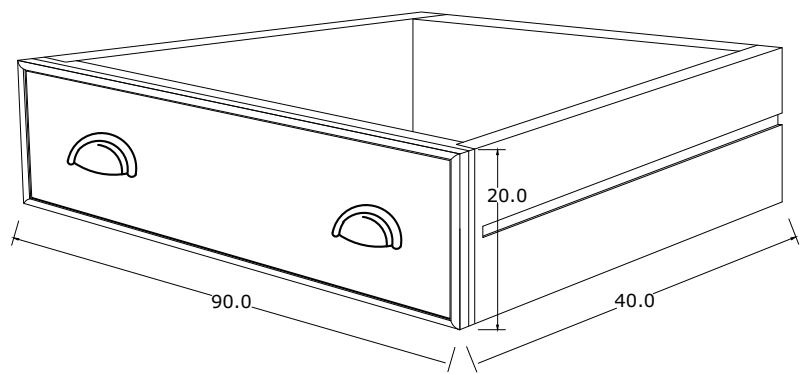

DRAWER